

TOSHIBA

LIQUID CRYSTAL DISPLAY DIVISION
PRODUCT INFORMATION

10cm COLOUR TFT-LCD MODULE
(4 TYPE)

LTM04C380K
(p-Si TFT)

FEATURES

- (1) 4"VGA display size for PDAs(personal digital assistants)
- (2) Super high resolution (202 pixel per inch)
- (3) 256k-colors

TENTATIVE

MECHANICAL SPECIFICATIONS

Item	Specifications
Dimensional Outline (typ.)	117.9(W) x 72.5(H) x 6.4(D) mm : see (3/9) page
Number of Pixels	640(W) x 480(H) pixels
Active Area	80.64(W) x 60.48(H) mm
Pixel Pitch	0.126(W) x 0.126(H) mm
Weight (approximately)	65g
Backlight	Single CCFL, Sidelight type

ABSOLUTE MAXIMUM RATINGS

Item	Min.	Max.	Unit	
Supply Voltage	(V _{DD})	(0.0)	(4.5)	V
	(V _{FL})	---	(1.5)	kVrms
FL Driving Frequency (f _{FL})	---	(160)	kHz	
Input Signal Voltage (V _{IN})	-0.3	V _{DD} +0.3	V	
Operating Temperature	0	50	°C	
Storage Temperature	-20	60	°C	
Storage Humidity (Max. wet bulb temperature = 39°C)	10	90	%RH	

ELECTRICAL SPECIFICATION (Ta=25°C)

Item	Min.	Typ.	Max.	Unit	Remarks	
Supply Voltage	(V _{DD})	3.0	3.3	3.6	V	
	(V _{FL})	---	(325)	---	Vrms	
FL Start Voltage	(750)	---	---	Vrms	Ta=0°C	
High Level Input Voltage (V _{IH})	0.8x V _{DD}	---	V _{DD}	V		
Low Level Input Voltage (V _{IL})	0	---	0.2x V _{DD}	V		
Current Consumption	*1 (I _{DD})	---	(115)	---	mA	
	*2 (I _{FL})	---	2.0	---	mArms	
*1*2 Power Consumption	---	(1.1)	---	W		

*1 : 8 color bars pattern

*2 : Except the efficiency of FL inverter

OPTICAL SPECIFICATION (Ta=25°C)

Item	Min.	Typ.	Max.	Unit	Remarks
Contrast Ratio (CR)	100	250	---	---	
Response Time	(t _{ON})	---	50	ms	
	(t _{OFF})	---	50	ms	
Luminance (L)	---	(130)	---	cd/m ²	I _{FL} =2.0mArms
Luminance (L)	---	(200)	---	cd/m ²	I _{FL} =3.0mArms

*The information contained herein is presented only as a guide for the applications of our products. No responsibility is assumed by Toshiba or other rights of the third parties which may result from its use. No license is granted by implication or otherwise under any patent or patent rights of Toshiba or others.

*The information contained herein may be changed without prior notice. It is therefore advisable to contact Toshiba before

DIMENSIONAL OUTLINE

TENTATIVE

Unit : mm

Standard tolerance : 0.5

Bezel less

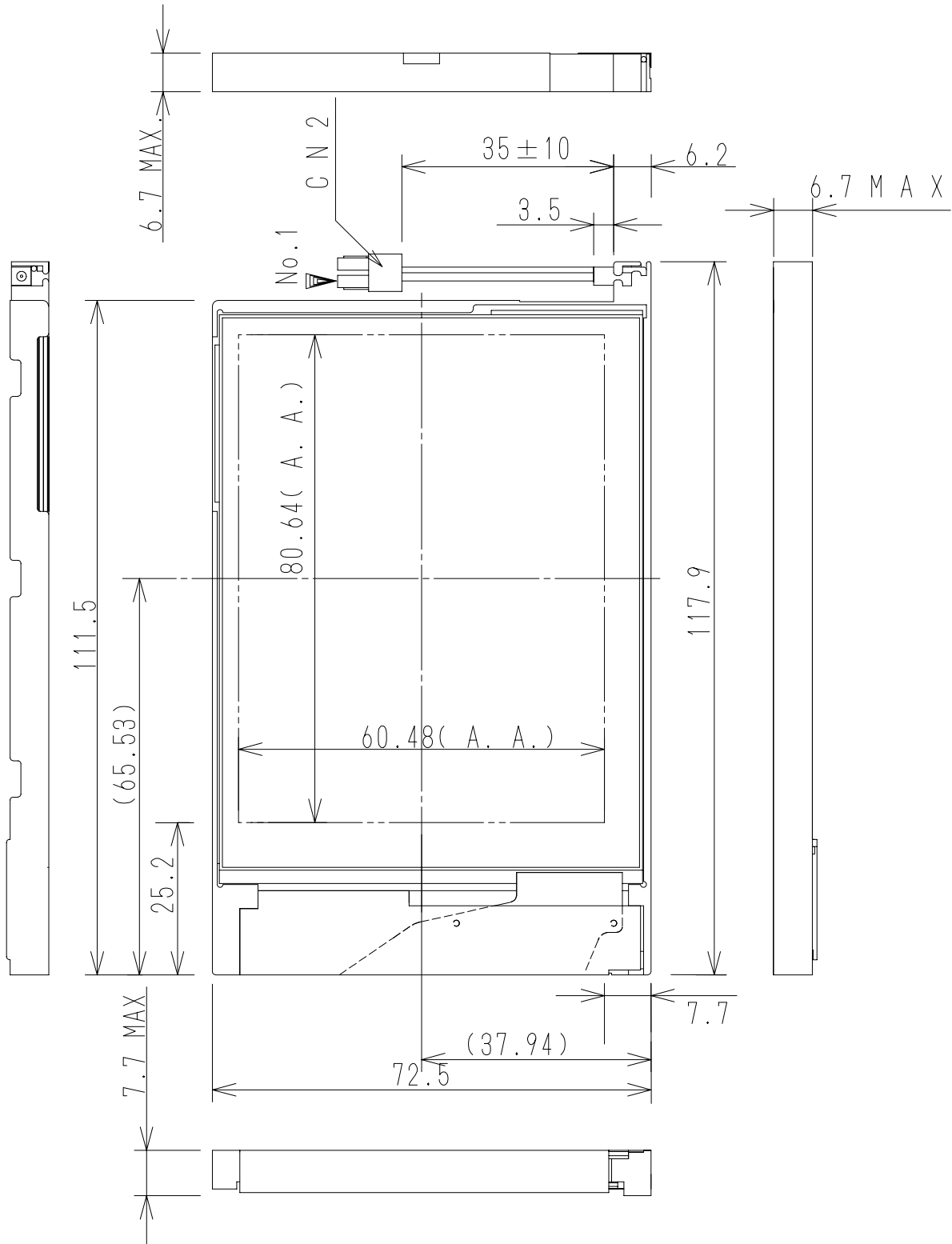

DIMENSIONAL OUTLINE



TENTATIVE

Unit : mm

Standard tolerance : 0.5

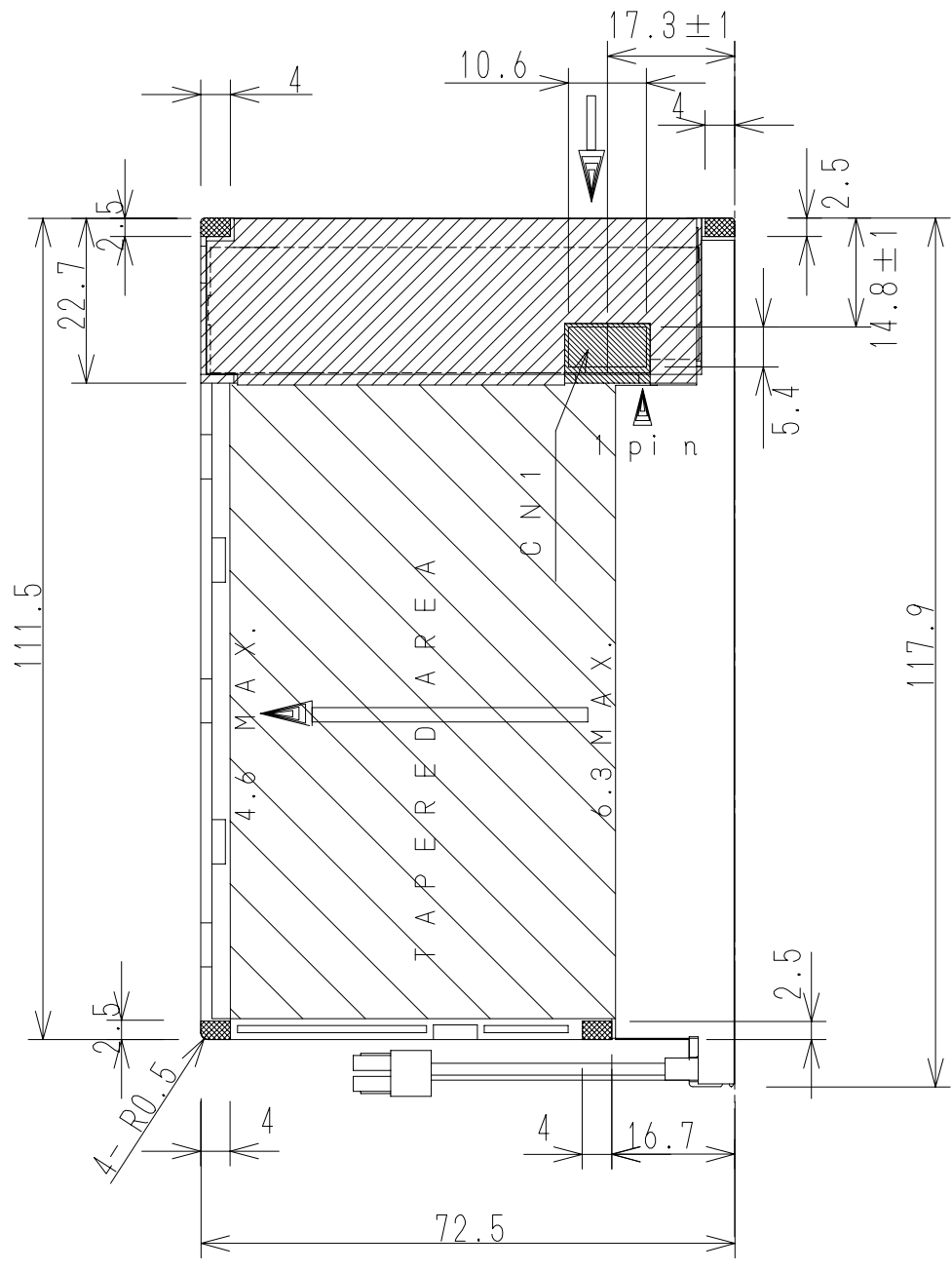
Bezel less

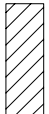

6. 7MAX.
 7. 0MAX.
 7. 7MAX.
 6. 4 ± 0.3 MOUNTING AREA
-  6. 7MAX.
 -  7. 0MAX.
 -  7. 7MAX.
 -  6. 4 ± 0.3 MOUNTING AREA

BLOCK DIAGRAM

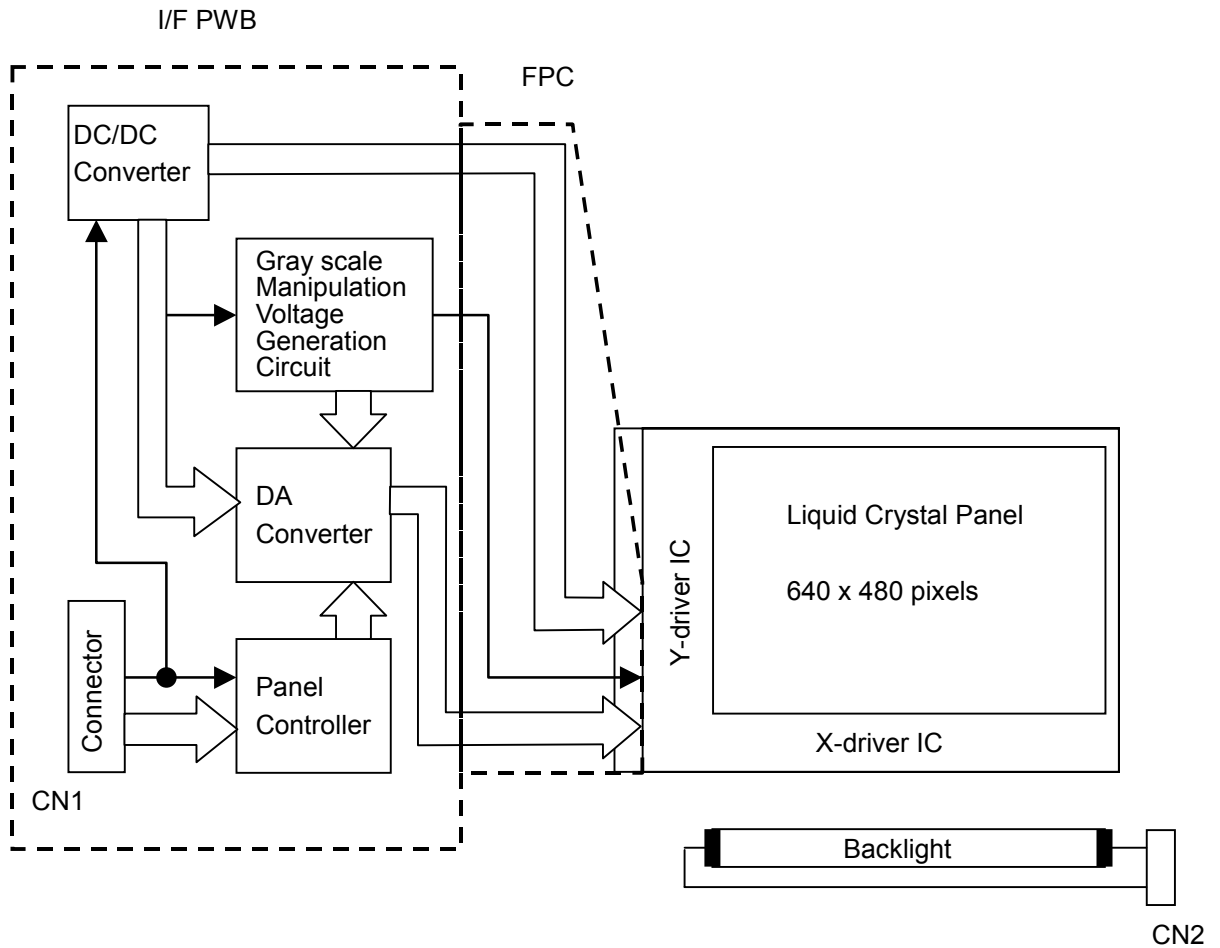

TIMING CHART

(1) Vertical Timing

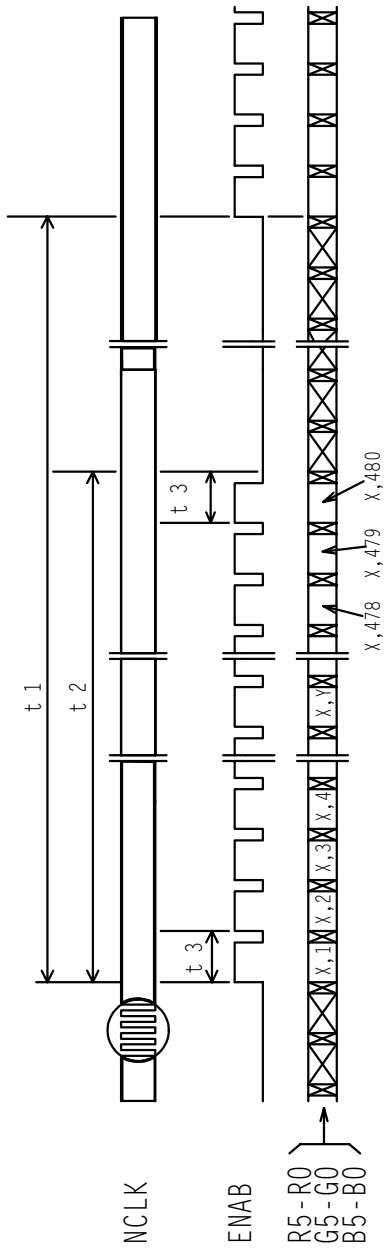

(2) Horizontal Timing

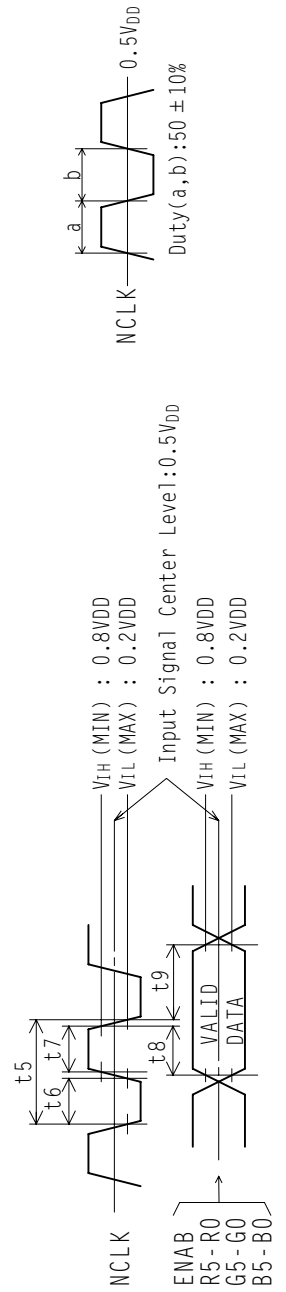
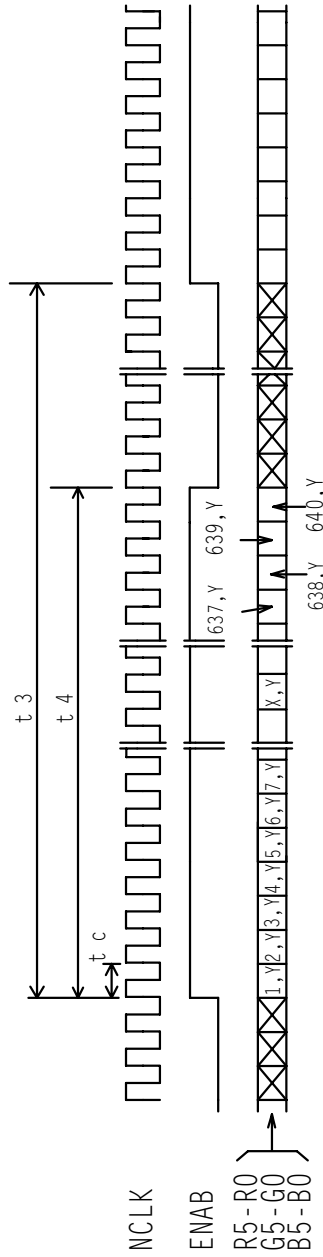

TIMING SPECIFICATION ^{1) 2) 3)}

Item	Symbol	Min.	Typ.	Max.	Unit	Remarks
Frame Period	t1	489 x t3	525 x t3 16.68	525 x t3 17.85	---	4)
Vertical Display Term	t2	480 x t3	480 x t3	480 x t3	---	
One Line Scanning Time	t3	784 x t5 31.5	800 x t5 31.78	860 x t5 36.5	---	4)
Horizontal Display Term	t4	640 x t5	640 x t5	640 x t5	---	
Clock Period	t5	35.0	39.72	46.5	ns	
Clock "L" Time	t6	10.0	---	---	ns	
Clock "H" Time	t7	7.0	---	---	ns	
Set Up Time	t8	5.0	---	---	ns	
Hold Time	t9	10.0	---	---	ns	

Note 1) When ENAB is fixed to "H" level or "L" level after NCLK input, the panel is displayed as black. However, it may be occurred a flicker on the display.

Note 2) When NCLK is fixed to "H" level or "L" level, the panel becomes white stage after several seconds.

Note 3) Do not change t1 and t3 values in the operation. When t1 or t3 is changed, the panel is displayed as black.

Note 4) Please adjust LCD operating signal timing and FL driving frequency, to optimize the display quality. There is a possibility that flicker is observed by the interference of LCD operating signal timing and FL driving condition (especially driving frequency).

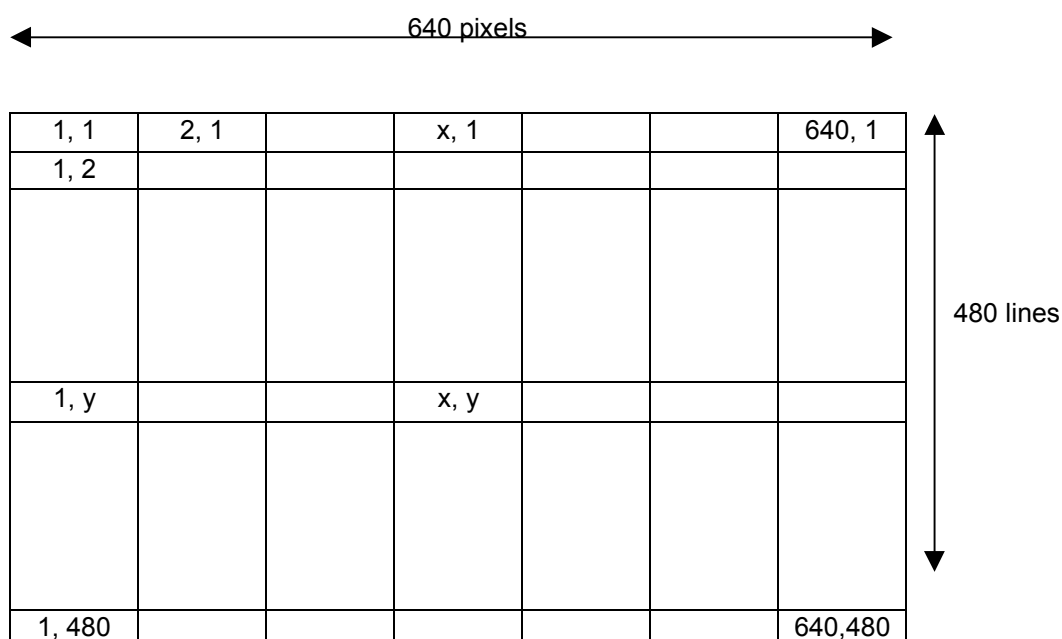

CONNECTOR PIN ASSIGNMENT FOR INTERFACE

CN1 INPUT SIGNAL

Connector : IL-FHJ-27S-HF / Japan Aviation Electronics Industry, Limited

Mating Connector : FPC(0.3mmPitch)

Terminal No.	Symbol	Function
1	VDD	+3.3V POWER SUPPLY
2	VDD	+3.3V POWER SUPPLY
3	VDD	+3.3V POWER SUPPLY
4	ENAB	COMPOUND SYNCHRONIZATION SIGNAL
5	B5	BLUE DISPLAY DATA (MSB)
6	B4	BLUE DISPLAY DATA
7	B3	BLUE DISPLAY DATA
8	B2	BLUE DISPLAY DATA
9	B1	BLUE DISPLAY DATA
10	B0	BLUE DISPLAY DATA (LSB)
11	GND	
12	G5	GREEN DISPLAY DATA (MSB)
13	G4	GREEN DISPLAY DATA
14	G3	GREEN DISPLAY DATA
15	G2	GREEN DISPLAY DATA
16	G1	GREEN DISPLAY DATA
17	G0	GREEN DISPLAY DATA (LSB)
18	GND	
19	R5	RED DISPLAY DATA (MSB)
20	R4	RED DISPLAY DATA
21	R3	RED DISPLAY DATA
22	R2	RED DISPLAY DATA
23	R1	RED DISPLAY DATA
24	R0	RED DISPLAY DATA (LSB)
25	GND	
26	NCLK	SAMPLING CLOCK
27	GND	

CN2 CCFL POWER SOURCE

Connector : HV-2S-C1/ Japan Aviation Electronics Industry, Limited

Mating Connector : HV-2P-HF/ Japan Aviation Electronics Industry, Limited

Terminal No.	Symbol	Function
1	VL	CCFL Power Supply (high voltage)
2	GL	CCFL Power Supply (low voltage)

256k (k=1024) COLORS COMBINATION TABLE

	Display	R5 R4 R3 R2 R1 R0	G5 G4 G3 G2 G1 G0	B5 B4 B3 B2 B1 B0	Gray Scale Level
Basic Color	Black	L L L L L L	L L L L L L	L L L L L L	-
	Blue	L L L L L L	L L L L L L	H H H H H H	-
	Green	L L L L L L	H H H H H H	L L L L L L	-
	Light Blue	L L L L L L	H H H H H H	H H H H H H	-
	Red	H H H H H H	L L L L L L	L L L L L L	-
	Purple	H H H H H H	L L L L L L	H H H H H H	-
	Yellow	H H H H H H	H H H H H H	L L L L L L	-
	White	H H H H H H	H H H H H H	H H H H H H	-
Gray Scale of Red	Black	L L L L L L	L L L L L L	L L L L L L	L 0
	Dark ↑ ↓ Light	L L L L L H	L L L L L L	L L L L L L	L 1
		L L L L H L	L L L L L L	L L L L L L	L 2
		:	:	:	L3...
		:	:	:	L60
		H H H H L H	L L L L L L	L L L L L L	L61
	H H H H H L	L L L L L L	L L L L L L	L62	
Red	H H H H H H	L L L L L L	L L L L L L	Red L63	
Gray Scale of Green	Black	L L L L L L	L L L L L L	L L L L L L	L 0
	Dark ↑ ↓ Light	L L L L L L	L L L L L H	L L L L L L	L 1
		L L L L L L	L L L L H L	L L L L L L	L 2
		:	:	:	L3...
		:	:	:	L60
		L L L L L L	H H H H L H	L L L L L L	L61
	L L L L L L	H H H H H L	L L L L L L	L62	
Green	L L L L L L	H H H H H H	L L L L L L	Green L63	
Gray Scale of Blue	Black	L L L L L L	L L L L L L	L L L L L L	L 0
	Dark ↑ ↓ Light	L L L L L L	L L L L L L	L L L L L H	L 1
		L L L L L L	L L L L L L	L L L L H L	L 2
		:	:	:	L3...
		:	:	:	L60
		L L L L L L	L L L L L L	H H H H L H	L61
	L L L L L L	L L L L L L	H H H H H L	L62	
Blue	L L L L L L	L L L L L L	H H H H H H	Blue L63	
Gray Scale of White & Black	Black	L L L L L L	L L L L L L	L L L L L L	L 0
	Dark ↑ ↓ Light	L L L L L H	L L L L L H	L L L L L H	L 1
		L L L L H L	L L L L H L	L L L L H L	L 2
		:	:	:	L3...
		:	:	:	L60
		H H H H L H	H H H H L H	H H H H L H	L61
	H H H H H L	H H H H H L	H H H H H L	L62	
White	H H H H H H	H H H H H H	H H H H H H	White L63	

**FOR SAFETY**

LCD module is generally designed with precise parts to achieve light weighted thin mechanical dimensions. In using our Modules, make certain that you fully understand and put into practice the warnings and safety precautions detailed in Engineering Information No.EE-N001,"CAUTIONS AND INSTRUCTIONS FOR TOSHIBA LCD MODULES". Refer to individual specifications and TECHNICAL DATA sheets (hereinafter called "TD") for more detailed technical information.

1) SPECIAL PURPOSES

A) Toshiba's Standard LCD Modules have not been customized for operation in extreme environments or for use in applications where performance failures could be life-threatening or otherwise catastrophic.

B) Since Toshiba's Standard LCD Modules have not been designed for operation in extreme environments, they must never be used in devices that will be exposed to abnormally high levels of vibration or shock which exceed Toshiba's published specification limits.

C) In addition, since Toshiba Standard LCD Modules have not been designed for use in applications where performance failures could be life-threatening or catastrophic, they must never be installed in aircraft navigation control systems (such as, but not limited to Traffic Collision Avoidance System and Air Traffic Indicator), in military defense or weapons systems, in critical industrial process-control systems (e.g., those involved in the production of nuclear energy), or in critical medical device or patient life-support systems.

2) DISASSEMBLING OR MODIFICATION

DO NOT DISASSEMBLE OR MODIFY the module. It may damage sensitive parts inside LCD module, and may cause scratches or dust on the display.

Toshiba does not warrant the module, if customer disassembled or modified it.

3) BREAKAGE OF LCD PANEL

DO NOT INGEST liquid crystal material, DO NOT INHALE this material, and DO NOT CONTACT the material with skin, if LCD panel is broken and liquid crystal material spills out.

If liquid crystal material comes into mouth or eyes, rinse mouth or eyes out with water immediately.

If this material contact with skin or cloths, wash it off immediately with alcohol and rinse thoroughly with water.

4) GLASS OF LCD PANEL

BE CAREFUL WITH CHIPS OF GLASS that may cause injuring fingers or skin, when the glass is broken.

5) ELECTRIC SHOCK

DISCONNECT POWER SUPPLY before handling LCD module.

DO NOT TOUCH the parts inside LCD module and the fluorescent lamp's connector or cables in order to prevent electric shock, because high voltage is supplied to these parts from the inverter unit while power supply is turned on.

6) ABSOLUTE MAXIMUM RATINGS AND POWER PROTECTION CIRCUIT

DO NOT EXCEED the absolute maximum rating values under the worst probable conditions caused by the supply voltage variation, input voltage variation, variation in parts' constants, environmental temperature, etc., otherwise LCD module may be damaged.

Employ protection circuit for power supply, whenever the specification or TD specifies it.

Suitable protection circuit should be applied for each system design.

7) DISPOSAL

When dispose LCD module, obey to the applicable environmental regulations.